

Ossature aluminium - Systèmes NFT-SL RAPID

compensation de tolérance supplémentaire à 5,5 cm

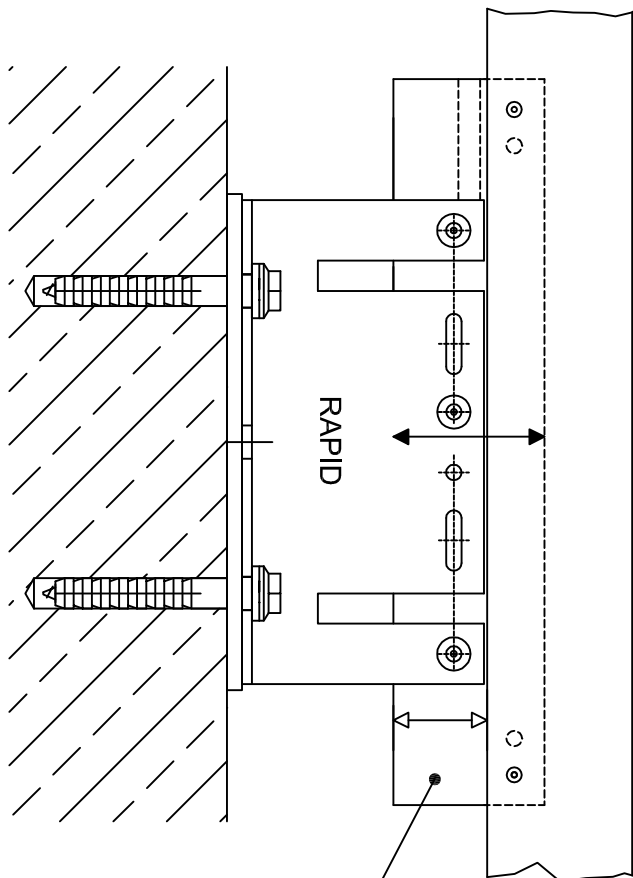

sans compensation de tolérance supplémentaire près de L + 30 mm

longueur L + 5 à 30 mm près de T/L-Profil x/50 mm

longueur L

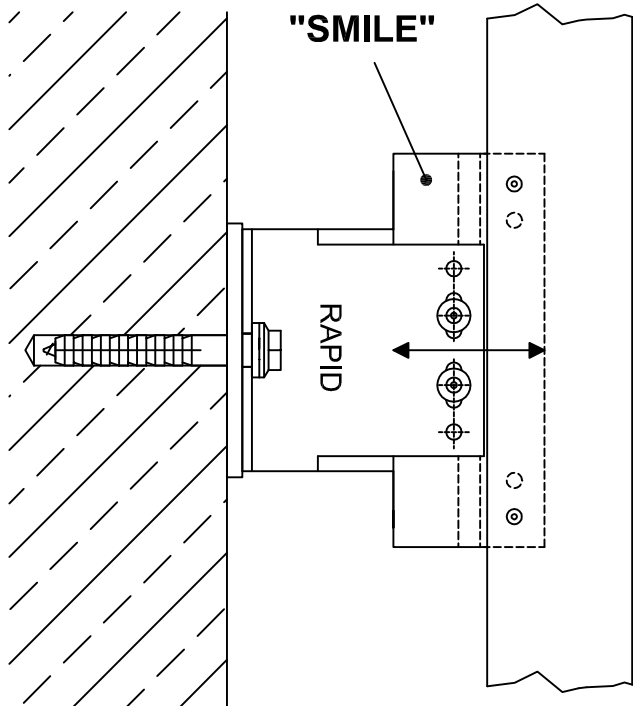
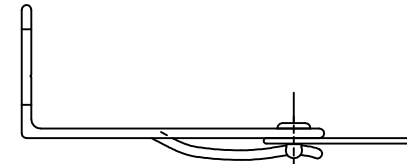

avec compensation de tolérance supplémentaire près de L + 60 mm

min. = longueur L + 32 mm
max. = longueur L + 60 mm

longueur L

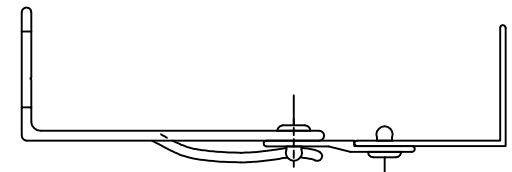

sous réserve de modification techniques

Ossature aluminium - Systèmes NFT-SL RAPID

rallonge "SMILE" pour point fixe avec profil -T

vue isométrique / coupe horizontale / vue

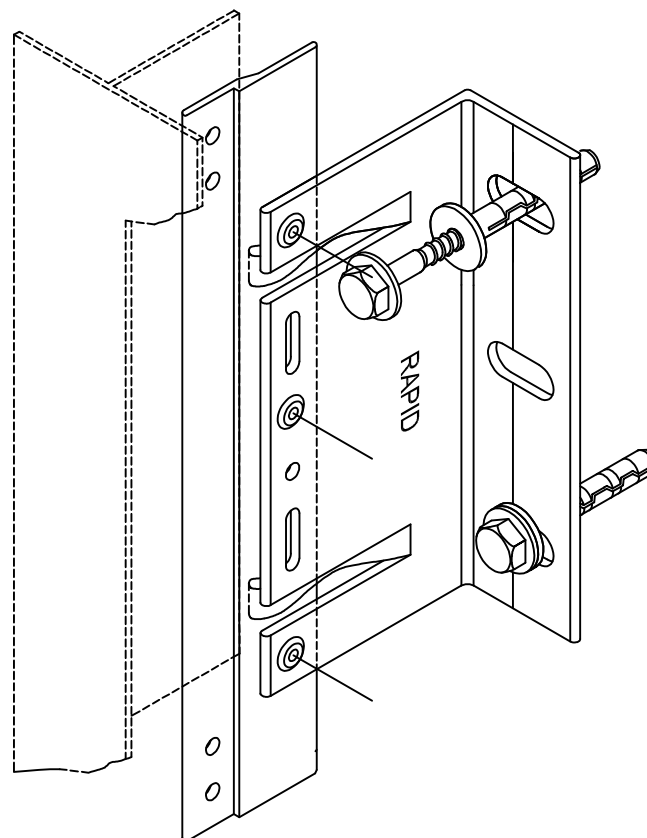
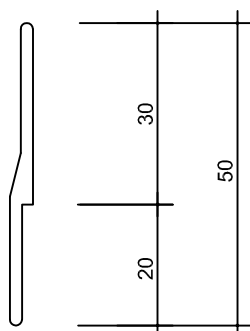
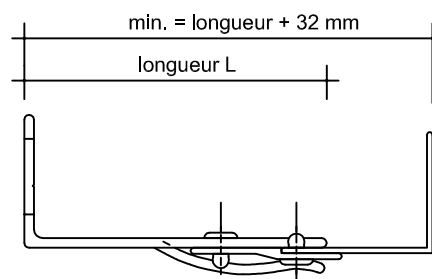
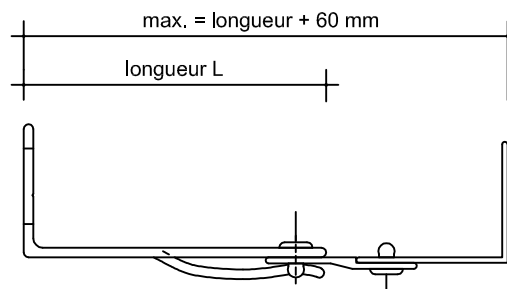
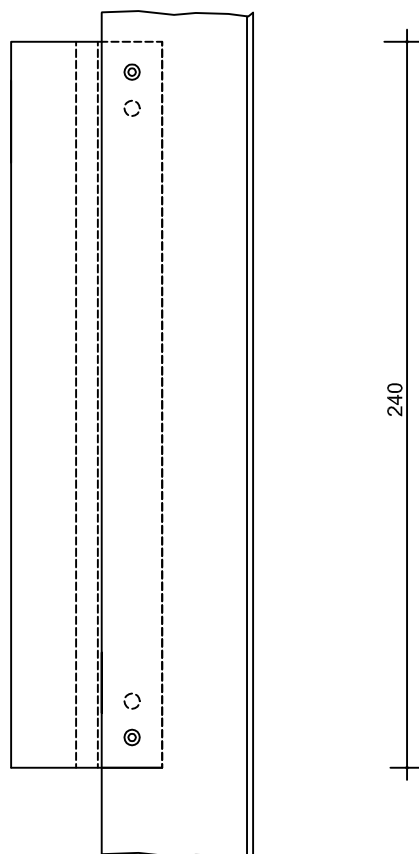

sous réserve de modification techniques

Ossature aluminium - Systèmes NFT-SL RAPID

rallonge "SMILE" pour point glissant avec profil -T

vue isométrique / coupe horizontale / vue

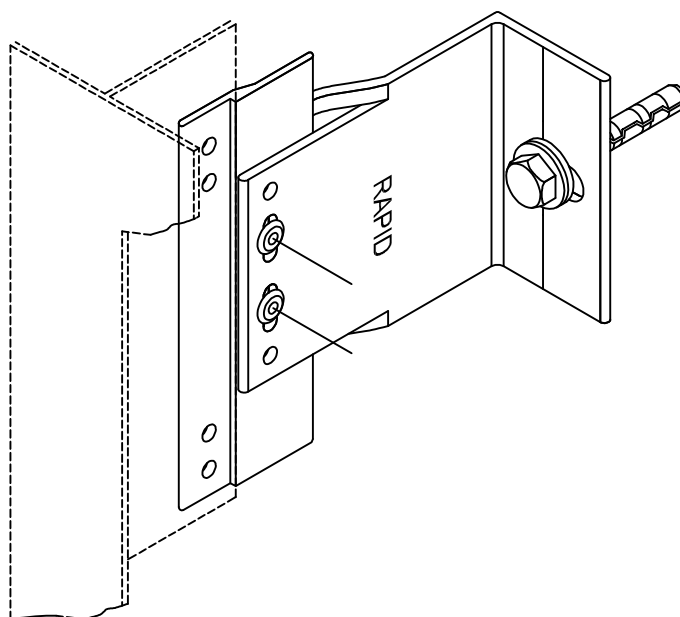
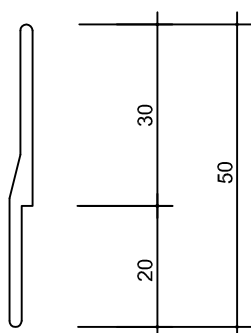
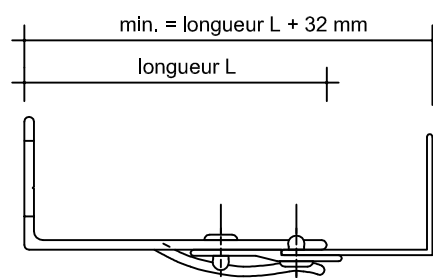
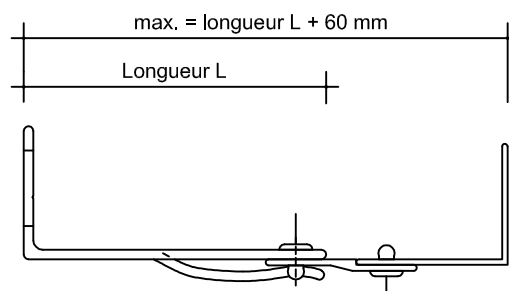
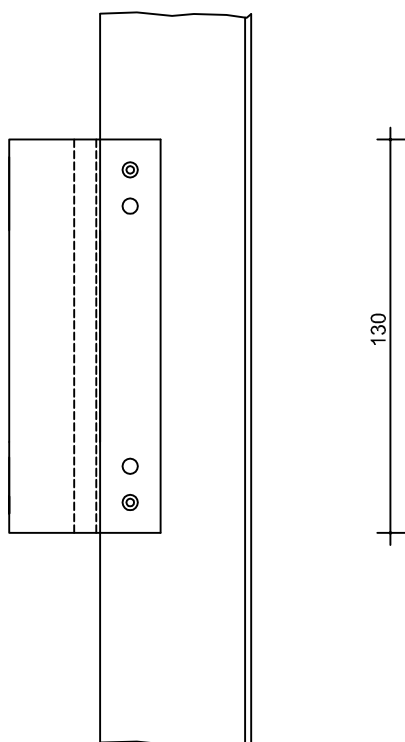

sous réserve de modification techniques